

SEIKI™

7KG

TOP LOAD WASHING MACHINE

SC-7000AU7TLW

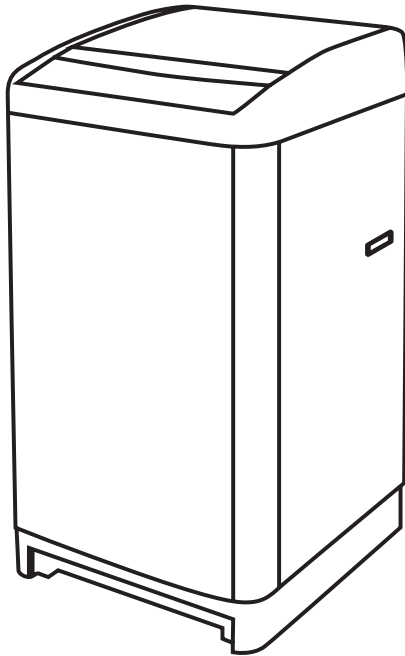

INSTRUCTION MANUAL

Please read this manual carefully before using, and keep it for future reference.

CONTENTS

| | |
|---|-----------|
| General Safety | 4 |
| Product Overview | 8 |
| Control Panel | 9 |
| Getting Started | 10 |
| Installing Bottom Cover | 10 |
| Levelling the appliance | 11 |
| Connecting the water inlet hose | 12 |
| Connecting the Drain Hose | 13 |
| Before First Use | 15 |
| Operations | 17 |
| Programs | 17 |
| How to Use | 18 |
| Delayed Washing | 19 |
| Adding detergent to a delayed wash | 19 |
| Hot / Cold / Warm Water Wash | 20 |
| Setting the water level and other processes | 20 |
| Set Different Water Levels | 20 |
| Set other Processes | 20 |
| Adding Fabric Softener | 20 |
| Others | |
| Load Sensor (Fuzzy Control) | 21 |
| Child Lock | 21 |
| Start of Washing | 21 |
| Cleaning and Maintenance | 22 |
| Troubleshooting | 25 |
| Specifications | 26 |
| Customer Helpline | Last Page |

GENERAL SAFETY

IMPORTANT INFORMATION

Read this manual thoroughly before you start using the Top Load Washing Machine. The safety precautions instructions reduces the risk of fire, electric shock and injury when correctly complied to.

Please follow all instructions and take notice of all warnings.

Pay close attention to messages that follow this safety alert symbol or the words **DANGER**, **WARNING** or **CAUTION**. These words will be used to alert you of potential hazards that and injure you and others. Following these instruction will tell you how to reduce the chance of injury and the possible dangers if instructions aren't followed.



WARNING

This symbol indicates when there is a serious risk of injury if you do not pay attention to the warnings.



CAUTION

This symbol indicates when to be careful to avoid a serious risk of injury to oneself or damage to property.

GENERAL SAFETY INSTRUCTIONS (Cont.)

ELECTRICAL SAFETY

- **Voltage:** Plug the appliance to a 230-240V ~ 50Hz, properly earthed power outlet, it must be in good working order.
- **Power connection:** Do not use an adaptor or an extension cord. Plug the power plug directly into a separate power point that cannot be accidentally turned off, and that is easily accessible so you can switch it off if needed.
- **Power cord:** Do not kink or damage the power supply cord. Make sure it is behind the appliance so no one can step on or place anything on the power supply cord or against it. A damaged power plug may overheat and cause a fire.
- **Damaged cord:** Do not use a cord that shows cracks or damage. Any damage to the cord may cause a short circuit, fire and/or electric shock. Contact our support centre on 1300 296 699 for advice
If the supply cord is damaged, it must be replaced by the manufacturer, its service agent or similarly qualified persons in order to avoid a hazard
- **Disconnection:** Never pull the power cord to unplug appliance. Grip the plug and pull straight out from the power point.
- **Electrical work:** If the installation of this appliance requires any electrical work, make sure it is carried out by an electrician.

To reduce risk of fire, electric shock or injury, always follow these basic precautions and accident prevention measures when using this appliance, including the below:

NOTE: This appliance should be installed by an authorised technician else warranty will be void.

INSTALLATION

- The product is heavy, be careful when moving it. To avoid back or other injury, have 2 people lift or mechanical aid when installing.
- When unboxing, thoroughly inspect the appliance carefully for any damage. If there is any damage, do not install the appliance. Contact our support centre on 1300 296 699 for advice.
- While installing the appliance make sure that the power cord is not bent or flattened.
- Make sure to remove all packaging materials such as foams and tapes before installing the appliance.
- Make sure if the machine is to be placed on carpet that the ventilation openings in the base are not obstructed
- Install the washing machine on a flat level and stable ground.
- Allow for 20mm of space on all sides of the washing machine.
- The openings shall not obstructed by carpet.
- This appliance is intended to be used in household and similar applications such as
 - Staff kitchen areas in shops, offices and other working environments;
 - Farm houses
 - By clients in hotels, motels and other residential type environments;
 - Bed and breakfast type environments;
 - Areas for communal use in blocks of flats or in launderettes.

GENERAL SAFETY INSTRUCTIONS (Cont.)

USAGE CONDITIONS AND RESTRICTIONS

- Supervision over children is to ensure that they do not play with the appliance. Never allow them to use, play with or crawl inside the appliance. Cleaning and maintenance must not be done by children.
- This appliance is not to be used by persons (including children) with reduced physical, sensory or mental capabilities, or lack of experience and knowledge, unless they are being supervised or been given instructions on how to use of the appliance in a safe way and understand the hazards with using this appliance incorrectly.
- Only for indoor domestic use only. It is not to be used for industrial or commercial use.
- Do not use this product for anything other than its intended purpose, and only use it as described in this manual. Do not attempt to alter or modify this appliance.
- In the process of a hot wash, the door window can become hot. Make sure not to touch it or that no children or pets come into contact with the door window.
- Ensure that emptying all pockets of every item to make sure that there is no hard, sharp objects such as coins, safety pins, bra wires, nails or screws can cause damage to the appliance and has a chance to block the pump.
- Damage or malfunction caused from foreign objects is not covered by your warranty to the appliance.
- Do not operate this appliance outdoors.
- Incorrect use can result in property damage, injury or death. We assume no liability for misuse of the appliance or noncompliance with these instructions.

GENERAL SAFETY INSTRUCTIONS (Cont.)

CLEANING AND MAINTENANCE

- Before cleaning or maintenance, always unplug the appliance from the power socket. Make sure you pull by the plug, not the cord as this can damage the power cord and cause a hazard.
- Only the filter requires regular cleaning, everything else is non user-serviceable parts. Do not try to repair, disassemble or modify the appliance.
- Check and clean the lint filter on a regular basis
- **Service:** Never try to repair, modify or replace any part of the appliance, unless this manual says you can do so. All other servicing is to be done by a qualified technician, or contact our support centre on 1300 296 699 for advice.

PRODUCT OVERVIEW

Scope of delivery

A Parts list

- 1 Transparent lid
- 2 Control panel
- 3 Housing
- 4 Detergent box
- 5 Lint filter
- 6 Wash/spin tub
- 7 Water supply hose connections
- 8 Drain pump filter
- 9 Drain hose connection
- 10 Adjustable leg (1)

Top/inside view



Front view



Back view



B Accessories included



- 11 Hot water supply hose
 - 12 Cold water supply hose
 - 13 Drain hose with elbow
- Base cover and screw for attaching it to the unit (not shown)

PRODUCT OVERVIEW (Cont.)

CONTROL PANEL



- 1. DETERGENT** These are indicators to show you how much detergent to use.
- 2. WASH PROGRAM** Select the Process button below for the desired WASH process. (indicator light above process button indicates wash process).
- 3. WATER LEVEL:** Choose the appropriate water level that matches your load size.
- 4. SET:** Press the SET button to set the Delay Time, Soak, Wash, Spin and Rinse Times.
- 5. DISPLAY:** This display shows you remaining times of a cycle or delay time.
Example for 20 minutes remaining: 20
Example for 2 hours remaining: 2 (no other numbers).
- 6. PROGRAM:** Press this button to select the WASH program you desire. The indicator lights above will illuminate which wash program you are currently on.
- 7. TEMP:** Press this button if you want to set a Hot, Cold or Warm setting. Hot (Flashing), Warm (Solid Light), Cold (off)
- 8. POWER:** Press once to POWER ON, Press again to POWER OFF.
Auto Power Shutoff: After a program has ended.
10 Mins of inactivity.
- 9. START/ PAUSE:** Press this button to start the Washing machine with all your options set. During operation, press button again to Pause temporarily and then press again to restart. NOTE: this is not a CANCEL button.

CHILD LOCK:

Press and Hold PROGRAM button for 4 seconds to activate CHILD LOCK Function.

GETTING STARTED

Before installing your appliance, read all safety instructions in this manual, especially the sections on electrical safety and installation.

UNPACKING

- When unpacking the appliance, be sure to keep all the packaging materials until you have made sure your new appliance is undamaged and in good working order. Plastic can be a suffocation hazard for babies and young children, make sure the materials are out of their reach.

TRANSPORTATION

- **CAUTION: VERY HEAVY!** Be sure to team lift the appliance with someone or mechanical aid is required when moving the appliance. Keep the appliance upright as possible when moving the appliance.

IMPORTANT! Installing the bottom cover

- Make sure the power cord is unplugged from the mains supply.
- Place some padding (such as a soft mat, blanket or thick towel) on the floor and gently lay the washing machine on the padding, back side down. Take care not to dent the housing.
- Insert the bottom cover into the hooks of the leg, pushing it straight until it reaches into the front hooks.
- Ensure to fasten the bottom cover with the supplied screws.
- Carefully set the washer upright.

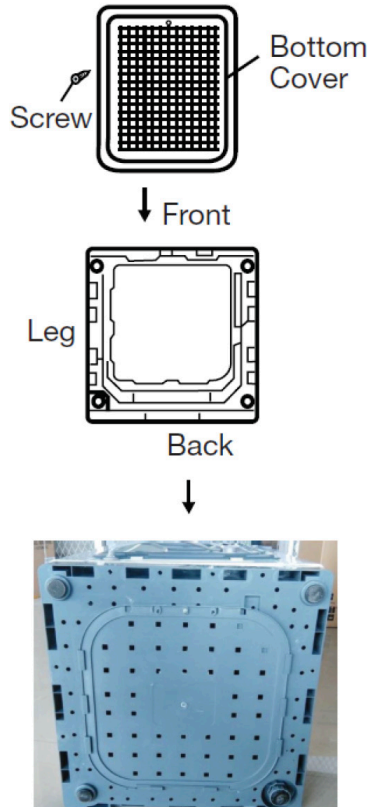

GETTING STARTED (Cont.)

LEVELLING THE APPLIANCE

IMPORTANT! Make sure to level the appliance carefully with a spirit level to ensure the most accurate levelling of the appliance. This is a must if your floor is unbalanced to level the washing machine.

- Make sure to position the appliance on a level and stable ground. If the floor is uneven you can adjust the feet by twisting the feet. Make sure to slightly incline the appliance first then adjust the leveling feet by twisting it clockwise or counter clockwise depending if you are raising or lowering the feet.

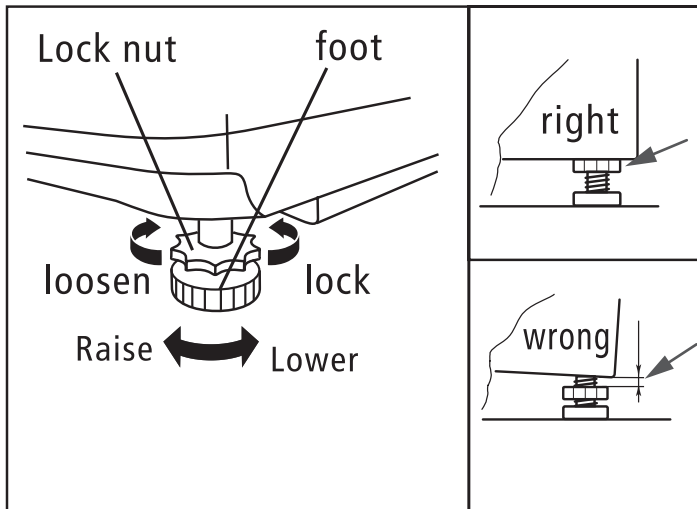

- By placing a spirit level on top of the appliance you can check correctly to aid you in adjusting the feet levelling nuts to adjust the appliance to be completely level.

Note: Make sure to avoid direct sunlight onto the appliance.

GETTING STARTED (Cont.)

CONNECTING THE WATER INLET HOSE

IMPORTANT! To prevent leakage or water damage please follow the below instructions. Do not kink, crush, modify or sever the water inlet hose.

- Connect the inlet pipe as indicated, there are two ways of connecting the inlet pipe.
- Minimum Inlet Water Pressure: 0.03MPa
Maximum Inlet Water Pressure: 0.8MPa

IMPORTANT! MAKE SURE to attach the STRAIGHT END to your Taps located in your laundry room. the Hose with **RED MARKINGS** is for hot water, the Hose with **BLUE MARKINGS** is for COLD Water.

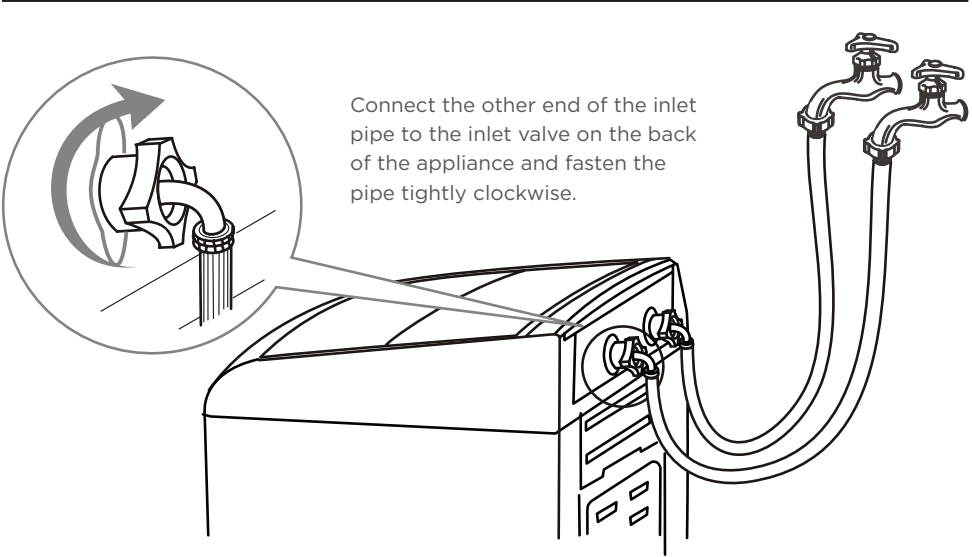
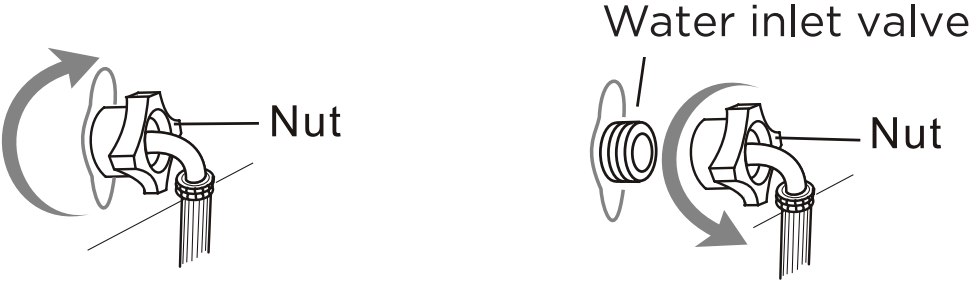

IMPORTANT!
Both the hot water and cold water hoses must be connected to your taps.

GETTING STARTED (Cont.)

CONNECTING THE DRAIN HOSE

- Do not kink or protract the drain hose. Position the drain hose correctly otherwise damage will result in water leakage.
- The height of the water drain hose can be from 70 to 100cm.
- Do not bend the drain hose or place it under the washing machine.
- Be sure to only use new hose sets when connecting the Washing Machine. Do not re-use old hoses.

There are two ways to place the end of drain hose:

1. For lower drain system

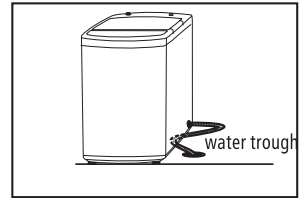
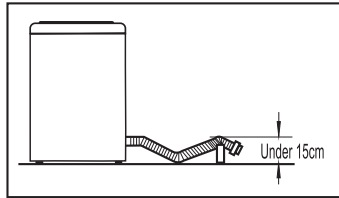
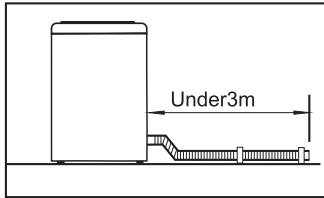

2. For upper drain system

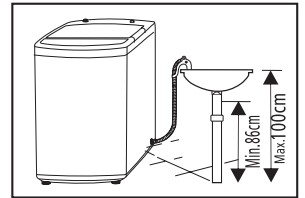
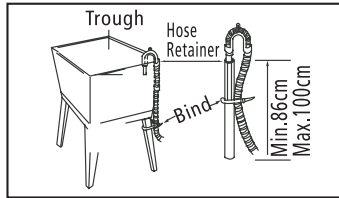
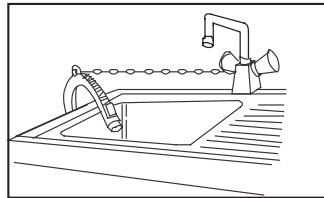

INSTRUCTIONS

BEFORE FIRST USE

- Make sure the washing machine is completely level as to previous instructions on how to level your washing machine.
- Make sure the water inlet hose is installed correctly.
- Make sure that the washing machine is plugged into the power socket.
- When the water inlet hose is installed, turn on the water supply on the tap.
- Properly install and set up the upper drain hose at no less than the height of 860mm, the water will overflow if it is below the recommended height of 860mm.

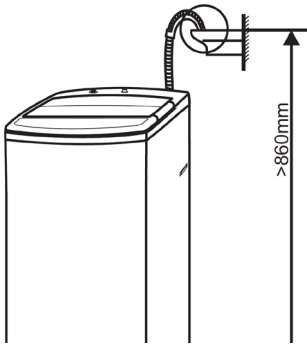

After the above steps have been completed, In a few simple steps you can select the type of wash you want and get started.

INSTRUCTIONS (Cont.)

- Make sure that the appliance is in a correct working temperature (0-40°C). If the appliance is used under 0°C the inlet valve and draining system may be damaged.
- Make sure that all labels are checked on items if they can be washed.
- Use non-foaming or less-foaming detergents which are more suitable for washing machines to wash correctly.

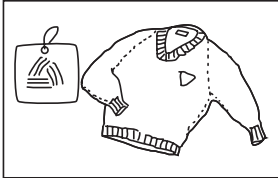

Check the label

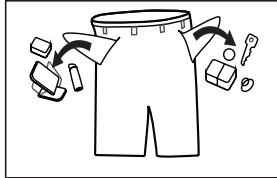

Take out the items out of the pockets

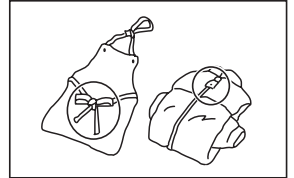

Knot the long strips, zip or button

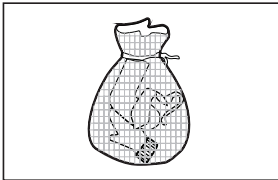

Put small clothes into the pillow slip

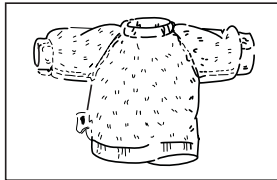

Turn easy-pilling and long-pile fabric inside out

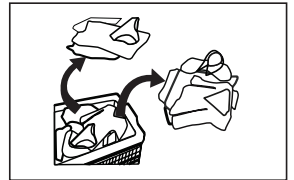

Separate clothes with different textures

WARNING

- Never use the washing machine to wash a single item at any given time, if you need to urgently wash an item, we suggest placing a few clothing items in there.
- Make sure that all labels are checked on items if they can be washed.
- Use non-foaming or less-foaming detergents which are more suitable for washing machines to wash correctly.
- Maximum mass of dry clothes is 7kg

INSTRUCTIONS (Cont.)

WASH CARE SYMBOLS

When choosing a wash program, check for any labels on your clothes and follow the instructions. Below are some commonly used symbols.

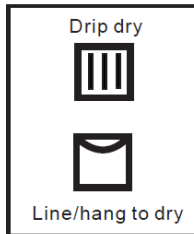
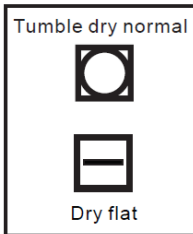
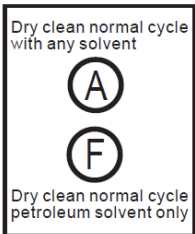
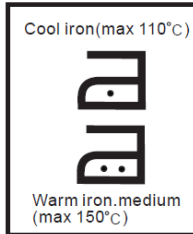
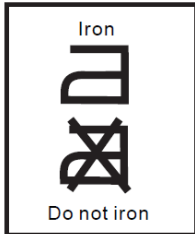
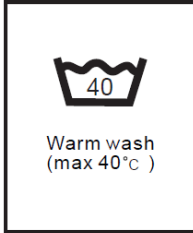
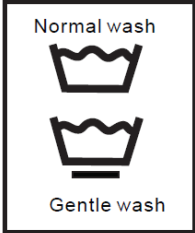

OPERATIONS

PROGRAMS

Select the desired programs according to the clothes that are being washed.

| Program | Suitable items | Default settings for wash processes | | |
|-------------------|---|--|-----------------------------------|------------------------|
| | | Wash time * (minutes) | Rinse type | Spin time (minutes) |
| Cotton ** | Normally soiled cotton clothing/items | Soak: 20 Wash: 15 | 4x Shower rinse | 9 |
| Normal | Lightly soiled clothing and other items | 5–12 *** | 2x Water saver rinse (20L–60L***) | 5–6 |
| Heavy Duty | Heavily soiled cotton clothing/items | 7–14 | 2x Water saver rinse (20L–60L***) | 7–8 |
| Quick | Less dirty clothes (daily wash) | 5 | 1x Water saver rinse (20L–60L***) | 3 |
| Blanket | Blanket or bulky items | 12 | 2x Water saver rinse (42L–60L***) | 8 |
| Delicate | Delicate fabrics, lingerie | 6 | 2x Water saver rinse (30L–60L***) | 2 |

*COTTON - is the standard washing programs to which the information in the energy efficiency label relates, and they are suitable to clean normal soiled cotton laundry and they are the most efficient programs in terms of energy and water consumption for washing that type of cotton laundry, the actual water temperature may differ from the declared cycle temperature.

NORMAL and **HEAVY DUTY** programs are specially designed for 100% fuzzy control. As the wash and spin times are determined by the load sensor, there is no default display. If you do not adjust, the washer will run within the default interval, depending on the sensor result.

HOW TO USE

Follow the below instructions on how to use the washing machine and the process involved. For this example, we will use the **BLANKET** program wash.

Use this program for washing blankets or other bulky items. It will automatically select the highest water level, but you can adjust this manually down to a lower level according to the size of your bulky item(s).

1. Press the **POWER ON/OFF** button and open the washer lid.
2. Press the **PROGRAM** button repeatedly and until the indicator for the **BLANKET** program flashes.
3. Dissolve an appropriate amount of washing detergent with a little lukewarm water, then pour the detergent solution directly into the tub of the washing machine.
4. Fold up the blanket and put it into the washing tub, as illustrated below.

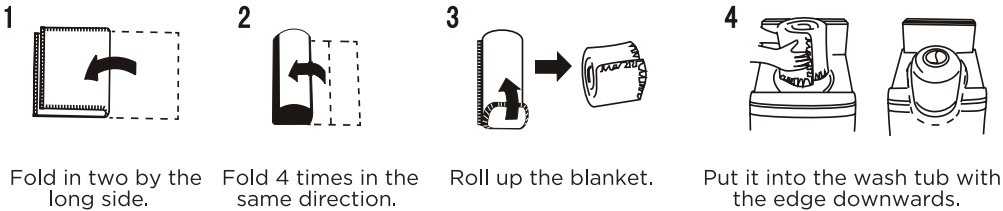

Fold in two by the long side.

Fold 4 times in the same direction.

Roll up the blanket.

Put it into the wash tub with the edge downwards.

5. Close the washer lid.
6. Press the **START/PAUSE** button for the washing program to start.
7. At the end of the washing program, a buzzer will sound to alert you that the program has finished before the power is shut off automatically.
8. Close the water taps and unplug the power plug from the wall outlet.
9. We recommend cleaning the lint filter after washing a blanket.

HOW TO USE (Cont.)

DELAYED WASHING

This washing machine has a 0-24 hour delay start function which you can set to determine the time when the washing program will finish.

NOTES: This function is not available for the **DELICATE** program. To avoid water leakage when using this function, make sure the water taps are open, the drain hose is properly installed and the washing load and detergent are properly prepared.

1. Put your washing in the machine, loading items uniformly in the tub.
2. Press the **POWER ON/OFF** button.
3. Select the required **PROGRAM** and/or **PROCESS**.
4. Press the **PROCESS** button until the Delay indicator light flashes, then press the **SET** button to select the desired time period (in hours) for the wash to finish.
5. Select the water level, if necessary.
6. Add any detergents.
7. Close the washer lid and press the **START/PAUSE** button.
8. After setting the delay, the corresponding light will illuminate and all other lights will be switched off about one minute later. From this time on until the delayed time only the **POWER** and **SET** buttons will respond when pressed.
9. To check the delayed program, press the SET button: the program will be indicated for 5 seconds. During these 5 seconds you can press the **WATER LEVEL** button and set the water level.
10. To cancel the delay, shut off the power.
11. To change the delay time, first cancel the delay, then set it again.

ADDING DETERGENT TO A DELAYED WASH

When using the delayed wash, we recommend you do not add detergent directly to the wash tub but follow the instructions below:

POWDER DETERGENT: either put powder detergent into the detergent box or, if you prefer to put it directly into the wash tub, wrap the powder in a small cloth.

LIQUID DETERGENT AND BLEACH: pour liquid detergent or bleach into the hole on the pulsator. Do not pour it directly into the tub as it may cause discolouration of your washing.

FABRIC SOFTENER: Refer to page 20

HOW TO USE (Cont.)

HOT / COLD / WARM WATER WASH

This top load washing machine must be connected to both a cold and a hot water tap. With both hoses connected to a cold and hot water tap, you can set the washer to use either just cold water for a cold water wash, or just hot water for a hot water wash, or both hot and cold water for a warm water wash.

To select the wash temperature, press the **TEMPERATURE** button.

- **COLD WASH:** the indicator light is off.
- **WARM WASH:** the indicator light is on.
- **HOT WASH:** the indicator light is flashing.

SETTING THE WATER LEVEL AND OTHER PROCESSES

You can set the water level for wash and rinse processes. For example, if you are sensitive to detergent residues in your washing, you may want to select a higher water level for rinsing.

TO SET DIFFERENT WATER LEVELS:

- Press the **PROCESS** button until the **WASH** light flashes; press the **WATER LEVEL** button to choose the appropriate water level (it will be shown on the display screen); press the **SET** button to set the wash time.
- Then press the **PROCESS** button until the **RINSE** light flashes; press the **WATER LEVEL** button to choose the appropriate water level; press the **SET** button to set the number of rinses.

TO SET OTHER PROCESSES:

- Then press the **PROCESS** button until the **SPIN** light flashes; press the **SET** button to set the **SPIN** time.
- Finally press the **START/PAUSE** button: the washer will start operating according to the set values for wash and rinse water levels, number of rinses and spin time.

ADDING FABRIC SOFTENER

You can program the washing machine to stop before the last rinse so that you can add fabric softener.

- Press and hold the **WATER LEVEL** button for 3 seconds to set the "Add Softener" program. Before the final rinse, the machine will stop and "**SF**" will show on the display. It will also play a beep sound to alert you to add fabric softener.
- You can add the diluted (mix with water) softener directly into the tub, then close the lid and press the **START/PAUSE** button to continue the program.

NOTE: If you disregard the alarm, the machine will repeat the alarm twice after 5 minutes of inactivity, and then resume the program.

OTHERS

LOAD SENSOR (FUZZY CONTROL)

This washing machine is equipped with a fuzzy logic function that will automatically detect the weight of your wash and choose the correct water level and wash and spin times for the **NORMAL** and **HEAVY DUTY** programs, and the correct water level for the **CUSTOM** and **QUICK** programs. You do not have to set these values.

CHILD LOCK

With the child lock activated, the machine will stop working automatically and sound an alarm if the washer lid is opened for 5 seconds.

TO SET THE CHILD LOCK:

- Press the **POWER ON/OFF** button to switch on the power, then press and hold the **PROGRAM** button for 4 seconds until a buzzer sounds. The child lock will be activated when the **START/PAUSE** button is pressed.
- To cancel the child lock, repeat the above steps.

START OF WASHING

The machine will start washing when the water inside the tub has reached two levels below the set level while the water will continue to flow in. This early start of washing will increase the wash time and allow the detergent to dissolve fully before the start of the set wash time.

THIS FUNCTION WILL BE INEFFECTIVE:

- When the first two water levels (15L or 20L) are selected.
- When the **DELICATE** or **BLANKET** program is selected.
- When **SOAK** is selected, after the soaking process.

WATER POWER

The water power affects the pause time of the pulsator and hence the intensity of the wash. It is automatically selected for the wash and rinse process, however, you can also adjust it yourself (except for the COTTON, DELICATE and BLANKET programs).

To adjust the water power level:

- Press the **SET** button after pressing the **START/PAUSE** button.
- Press the **SET** button again for Standard Water Power. The display will show "H0"
- Press the **SET** button again repeatedly to increase the water power level from, H1, H2, H3 to the Strongest H4.
- Press the **SET** button again repeatedly to decrease the water power level from L1, L2, L3 to the weakest L4,

CLEANING AND MAINTENANCE

WARNING:

- Before starting maintenance, ensure that the appliance is unplugged and close the tap.

CLEANING THE CABINET

Proper maintenance on the washing machine can extend its working life. The surface can be cleaned with diluted non-abrasive neutral detergents when necessary. If there is any water overflow, use a wet cloth to wipe it off immediately. Make sure no sharp items are used to clean the appliance.

- Use a gentle cloth to wipe off the water and dirt on the surface of the washing machine after every use. Detergent, properllant and other chmicals are not allowed to be used to clean the washing machine surface as it can damage the plastic accessories.

CLEANING THE WATER INLET

- 1 Switch on the power, followed by shutting off the tap
- 2 Let the washer work for 5 seconds so that the water flows into the tub through the hose, then turn off the power.
- 3 Unload the water inlet hose and clean the mesh bag, then re-install everything.

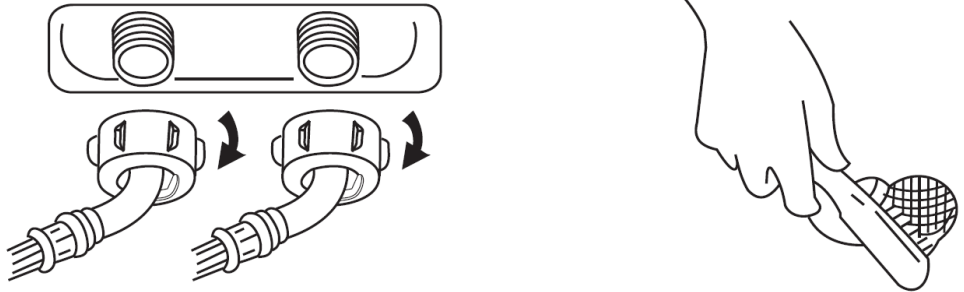

CLEANING AND MAINTENANCE (Cont.)

Cleaning the lint filter (suggested interval: every week)

Take out the lint filter as illustrated below. Open the filter and rinse it clean under running water, taking care not to damage any parts. Reinstall the filter, making sure it fits securely behind the cover clasp and latches and locks securely into place.

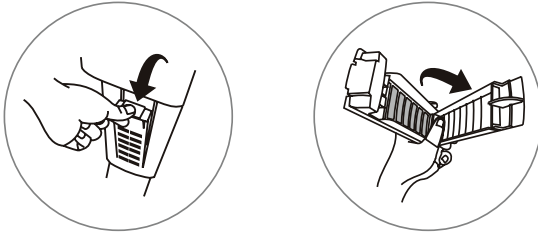

Cleaning the water inlet valve (suggested interval: every 6 months)

To avoid blockage of the mesh filter at the water inlet after long time use, detach the water inlet hose, making sure you have turned off the water supply at the taps beforehand. Take the mesh filter out of the water inlet valve and clean the filter with a soft brush. Then assemble the mesh filter back into the valve and reconnect the water inlet hose.

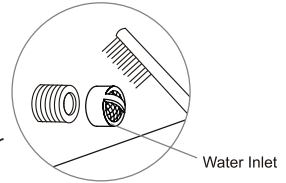

Cleaning the hose filter (suggested interval: every 6 months)

To avoid blockage of the hose filter after long time use, detach the water inlet hose, making sure you have turned off the water supply at the taps beforehand. Turn the nut anticlockwise to take off the hose, clean the filter under running water or with a soft brush, then reconnect the hose.

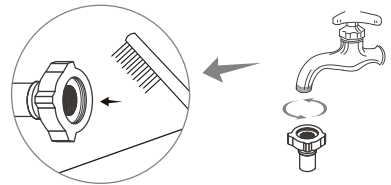

CLEANING AND MAINTENANCE (Cont.)

CLEANING THE DRAIN PUMP FILTER

We recommend that you clean the drain pump filter regularly (at least once a month) to avoid blockages created by bobby pins, coins and excess lint.

Proceed as follows:

1. Disconnect the washer from the power source.
2. If necessary, wait until the water has cooled down.
3. Place a container underneath the pump opening to collect any spillage (see below, left).
4. Turn the filter cap anticlockwise to take it out gently (see below, right). Always keep a rag nearby to dry up water spillage when removing the pump filter.

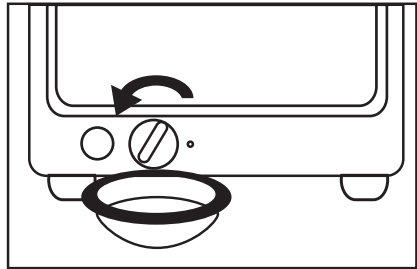
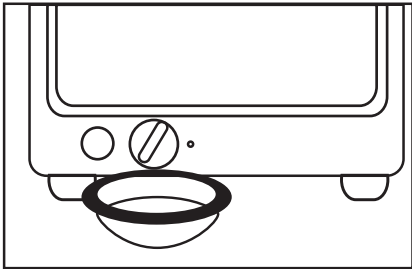

5. To remove any objects from the filter, wash it thoroughly in a basin or under running water (see below, left).
6. Put the cap back and place the filter back in its seat (see below, right).

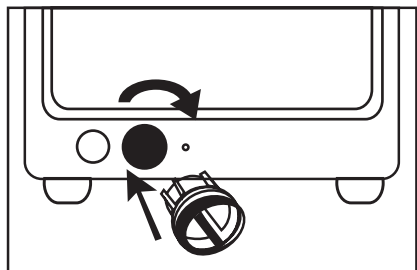
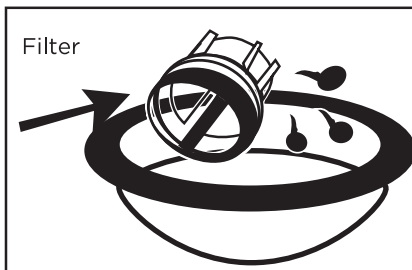

TROUBLESHOOTING

When the following problems occur, the microcomputer inside the washer will detect the abnormal condition. An electronic buzzer will sound for approximately 10 seconds, an error message will flash as shown below and the washer will stop operating.

| Type of problem | Error message | Where to check |
|---|---------------|--|
| Water does not flow into the wash/spin tub. | E1 | <ul style="list-style-type: none"> • Turn on the water supply tap. • Check whether the water supply has been cut off. • Check whether the mesh filter of the water inlet is clogged. |
| Water does not drain out. | E2 | <ul style="list-style-type: none"> • Check and make sure the drain hose is properly connected and installed. • Check the drain hose for kinks or obstructions. • Check whether the drain hose is clogged. • Check whether the drain hose is installed too high off the ground. • Check whether the filter of the drain pump is clogged. • Check the lint bag filter inside the drum is clean (empty). • Check the lint filter at the lower back of the machine is not obstructed. |
| The washer does not spin. | E3 | <ul style="list-style-type: none"> • Check whether your washing is piled at one side of the tub. If so, redistribute the load evenly inside the tub. • Check and make sure the washer is installed on an even, level surface. |
| | E4 | <ul style="list-style-type: none"> • Close the washer lid. |
| The buzzer keeps buzzing. | E5 | <ul style="list-style-type: none"> • Check whether the child lock is set. • Close the washer lid. |
| Other problems. | EA EC | <ul style="list-style-type: none"> • Press the POWER ON/OFF button to turn off the power, then contact our after sales support line to arrange a service. |

NOTE: Press the START/PAUSE button once to release the emergency stop and cancel the error message; press it again to restart the operation.

SPECIFICATIONS

| | |
|--------------------------------|--|
| Power Supply | 230-240V-50Hz |
| Standard Water Pressure | 0.03MPa-0.8MPa |
| Washing Capacity | 7KG |
| Rated Input Power | 400W |
| Water Capacity | 60L |
| Spin Speed | 850 RPM |
| Dimensions | 540 (w) x 562 (d) x 930 (h) mm - (1240mm door open) |
| Weight | Net: 33 kg / Gross: 37 kg |

SEIKI™

CUSTOMER HELPLINE:

info@ayonz.com

DISTRIBUTED BY:

Ayonz Pty Ltd