

SEIKI

7KG & 3.5KG FRONT LOAD WASHER & DRYER COMBO



INSTRUCTION MANUAL

MODEL: SC-7350AU9FLCO

Please read this manual carefully before using, and keep it for future reference.

CONTENTS

General Safety	4
Product Overview	8
Getting Started	10
Levelling the appliance	11
Connecting the water inlet hose	12
Connecting the Drain Hose	13
Instructions	15
Operations	18
Cleaning and Maintenance	21
FAQs	25
Specifications	26
Customer Helpline	28

GENERAL SAFETY

IMPORTANT INFORMATION

Read this manual thoroughly before you start using the Front Load Washing Machine.

The safety precautions instructions reduces the risk of fire, electric shock and injury when correctly complied to.

Please follow all instructions and take notice of all warnings.

Pay close attention to messages that follow this safety alert symbol or the words **DANGER**, **WARNING** or **CAUTION**. These words will be used to alert you of potential hazards that and injure you and others. Following these instruction will tell you how to reduce the chance of injury and the possible dangers if instructions aren't followed.



WARNING

This symbol indicates when there is a serious risk of injury if you do not pay attention to the warnings.



CAUTION

This symbol indicates when to be careful to avoid a serious risk of injury to oneself or damage to property.

ELECTRICAL SAFETY

- **Voltage:** Plug the appliance to a 220-240V, 50Hz, properly earthed power outlet, it must be in good working order.
- **Power connection:** Do not use an adaptor or an extension cord.
Plug the power plug directly into a separate power point that cannot be accidentally turned off, and that is easily accessible so you can switch it off if needed.
- **Power cord:** Do not kink or damage the power supply cord. Make sure it is behind the appliance so no one can step on or place anything on the power supply cord or against it. A damaged power plug may overheat and cause a fire.
- **Damaged cord:** Do not use a cord that shows cracks or damage. Any damage to the cord may cause a short circuit, fire and/or electric shock.
Contact our support centre on 1300 296 699 for advice
- **Disconnection:** Never pull the power cord to unplug appliance. Grip the plug and pull straight out from the power point.
- **Electrical work:** If the installation of this appliance requires any electrical work, make sure it is carried out by an electrician.

GENERAL SAFETY INSTRUCTIONS (Cont.)

To reduce risk of fire, electric shock or injury, always follow these basic precautions and accident prevention measures when using this appliance, including the below:

NOTE: This appliance should be installed by an authorised technician else warranty will be void.

INSTALLATION

- The product is heavy, be careful when moving it. To avoid back or other injury, have 2 people lift or mechanical aid when installing.
- When unboxing, thoroughly inspect the appliance carefully for any damage. If there is any damage, do not install the appliance. Contact our support centre on 1300 296 699 for advice.
- While installing the appliance make sure that the power cord is not bent or flattened.
- Make sure to remove all packaging materials such as foams and tapes before installing the appliance.
- Make sure if the machine is to be placed on carpet that the ventilation openings in the base are not obstructed
- Install the washing machine on a flat level and stable ground.
- If not wall mounted, be sure that the appliance is not placed on any soft materials such as plastics or foams.
- Do not install appliance in a tight fitted cabinet.
- Do not install appliance near other heat sources such as radiators, heaters or direct sunlight.
- Install appliance on a flat level and stable ground.

WARNING

- Make sure that transport packaging is removed from the rear of the dryer. Do not overload the washer/dryer with too many clothes.
- Exhaust air must not be discharged into a flue which is used for exhausting fumes from appliances burning gas or other fuels.
- Appliance must not be installed behind a lockable door, a sliding door or a door with a hinge on the opposite side to that of the tumble dryer, in such a way that a full opening of the tumble dryer door is restricted.

GENERAL SAFETY INSTRUCTIONS (Cont.)

USAGE CONDITIONS AND RESTRICTIONS

- Supervision over children is to ensure that they do not play with the appliance. Never allow them to use, play with or crawl inside the appliance. Cleaning and maintenance must not be done by children.
- This appliance is not to be used by persons (including children) with reduced physical, sensory or mental capabilities, or lack of experience and knowledge, unless they are being supervised or been given instructions on how to use of the appliance in a safe way and understand the hazards with using this appliance incorrectly.
- Only for indoor domestic use only. It is not to be used for industrial or commercial use.
- Do not use this product for anything other than its intended purpose, and only use it as described in this manual. Do not attempt to alter or modify this appliance.
- In the process of a hot wash, the door window can become hot. Make sure not to touch it or that no children or pets come into contact with the door window.
- Ensure that emptying all pockets of every item to make sure that there is no hard, sharp objects such as coins, safety pins, bra wires, nails or screws can cause damage to the appliance and has a chance to block the pump.
- Damage or malfunction caused from foreign objects is not covered by your warranty to the appliance.
- Do not operate this appliance outdoors.
- Incorrect use can result in property damage, injury or death. We assume no liability for misuse of the appliance or noncompliance with these instructions.
- Maximum load of dry clothes is 3.5kg for Drying / 7.0kg for Washing.
- Do not block any ventilation openings. Ensure that vents are not covered by anything.
- Do not use this product for anything other than its intended purpose, and only use it as described in this manual. Do not attempt to alter or modify this appliance.
- Only load items that are suitable for the clothes dryer.
- Do not place any open source flames on the dryer such as candles, etc..
- The door/window will be hot after a long cycle, be sure not to touch the window and to keep children away from the appliance.
- **WARNING:** Never stop a tumble dryer before the end of the cycle unless all items are quickly removed and spread out so that the heat is dissipated.

GENERAL SAFETY INSTRUCTIONS (Cont.)

- The only part that can be changed is the filter, other than this nothing else in the dryer contains user serviceable parts. Do not open, disassemble or try to repair the appliance yourself. Only have this appliance serviced by a qualified technician.
- Incorrect use can result in property damage, injury or death. We assume no liability for misuse of the appliance or noncompliance with these instructions.

CLEANING AND MAINTENANCE

- Before cleaning or maintenance, always unplug the appliance from the power socket. Make sure you pull by the plug, not the cord as this can damage the power cord and cause a hazard.
- Only the filter requires regular cleaning, everything else is non user-serviceable parts. Do not try to repair, disassemble or modify the appliance.
- Check and clean the lint filter on a regular basis. Wipe the glass and seal after each wash to remove lint and stains. If lint builds up it can cause leaks. Remove any coins, buttons and other objects from the seal after each wash.
- **Service:** Never try to repair, modify or replace any part of the appliance, unless this manual says you can do so. All other servicing is to be done by a qualified technician, or contact our support centre on 1300 296 699 for advice.

CAUTION

ITEMS BELOW ARE NOT SUITABLE FOR DRYING. IT CAN CAUSE FIRE IN THE APPLIANCE OR EXTENSIVE DAMAGE. DO NOT PLACE FOLLOWING IN THE APPLIANCE

- Items containing rubber or foam like rubber or any other similar textured materials.
- Items that are spotted or soaked with cooking oil or any other flammable items. These other items include kerosene, stain removers, dry-cleaning solvents, alcohol, petrol, turpentine, waxes, hair care products, wax removers.
- Washing the items vigourously beforehand in hot water with extra detergent will reduce, but not completely eliminate the hazard.
- Undergarments that contain metal reinforcements (such as underwire bras). Plastic articles such shower caps and waterproof bibs.
- Rubber-backed articles, clothes with foam rubber pads, pillows, galoshes and rubber coated tennis shoes.
- Fabric softeners or similar products unless recommended by product manufacturer for use in a clothes dryer.

GENERAL SAFETY INSTRUCTIONS (Cont.)

CAUTION

- Do not use the tumble dryer if industrial chemicals have been used for cleaning.
- Do not dry unwashed items in the dryer.
- Do not allow lint to accumulate around the tumble dryer. Clean the Lint Trap and Filter after every use.
- Enough ventilation has to be provided to avoid the backflow of gases into the room from appliances burning other fuels including open fires.
- Remove all objects from pockets such as lighters and matches.
- If it is unavoidable that fabrics that contain vegetable or cooking oil or have been contaminated by hair care products be placed in a tumble dryer they should first be washed in hot water with extra detergent - this will reduce, but not eliminate, the hazard.



WARNING: Risk of fire

This symbol alerts you to take care as oil-affected items can ignite, especially when exposed to heat, such as in a clothes dryer. The items become warm, causing an oxidation reaction in the oil. Oxidation causes heat. If the heat cannot escape, the items can become hot enough to catch fire. Piling, stacking or storing oil-affected items can prevent heat from escaping and so it will create a fire hazard.

PRODUCT OVERVIEW

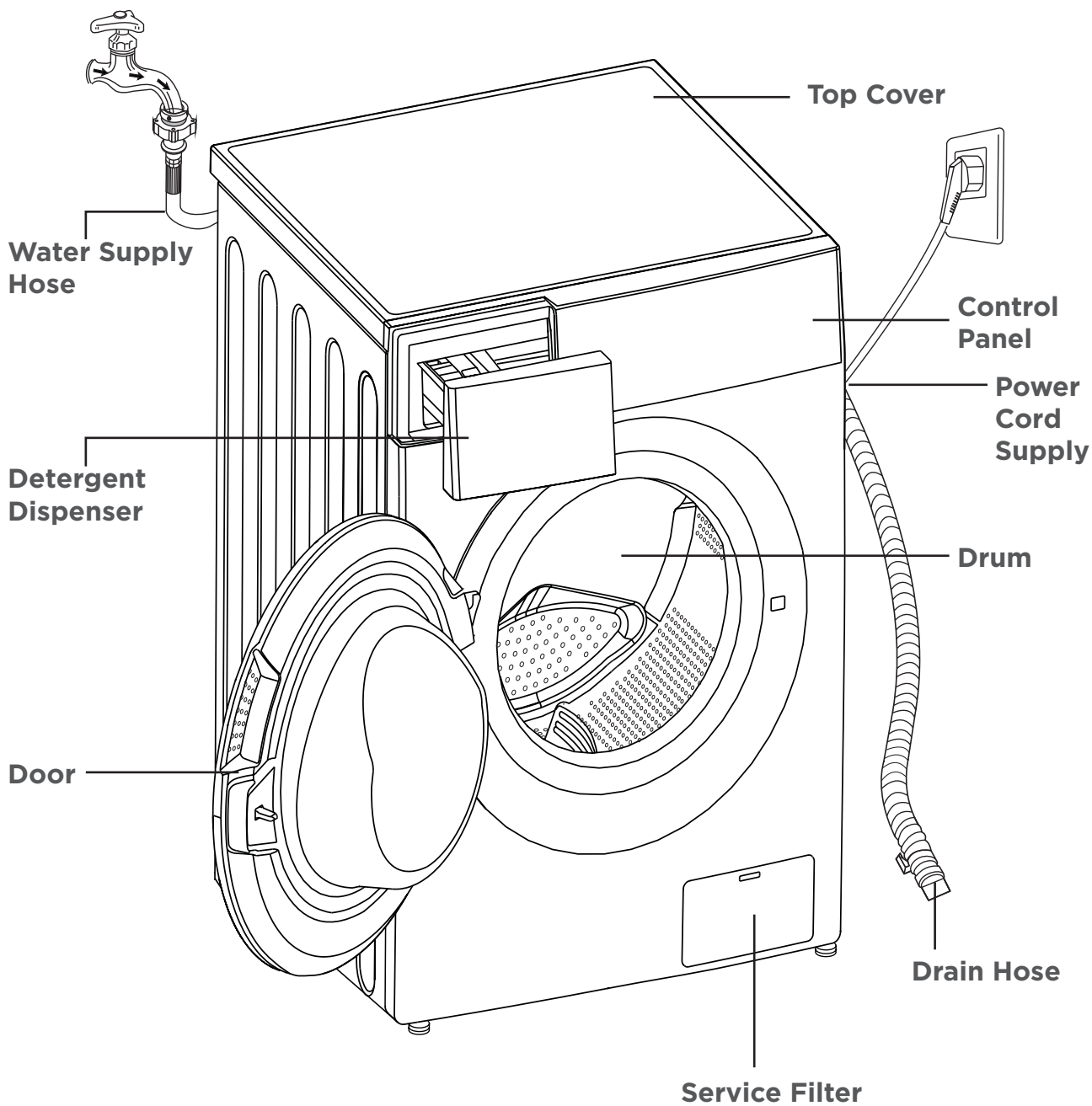

Accessories

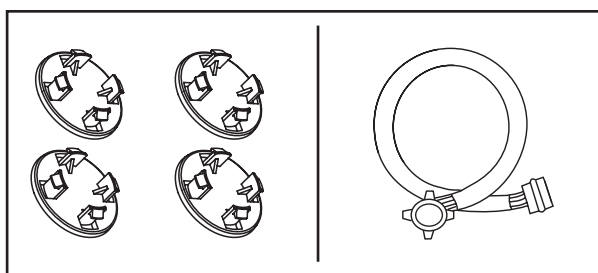

Transport Hole Plug

Supply Hose Cold Water

PRODUCT OVERVIEW (Cont.)

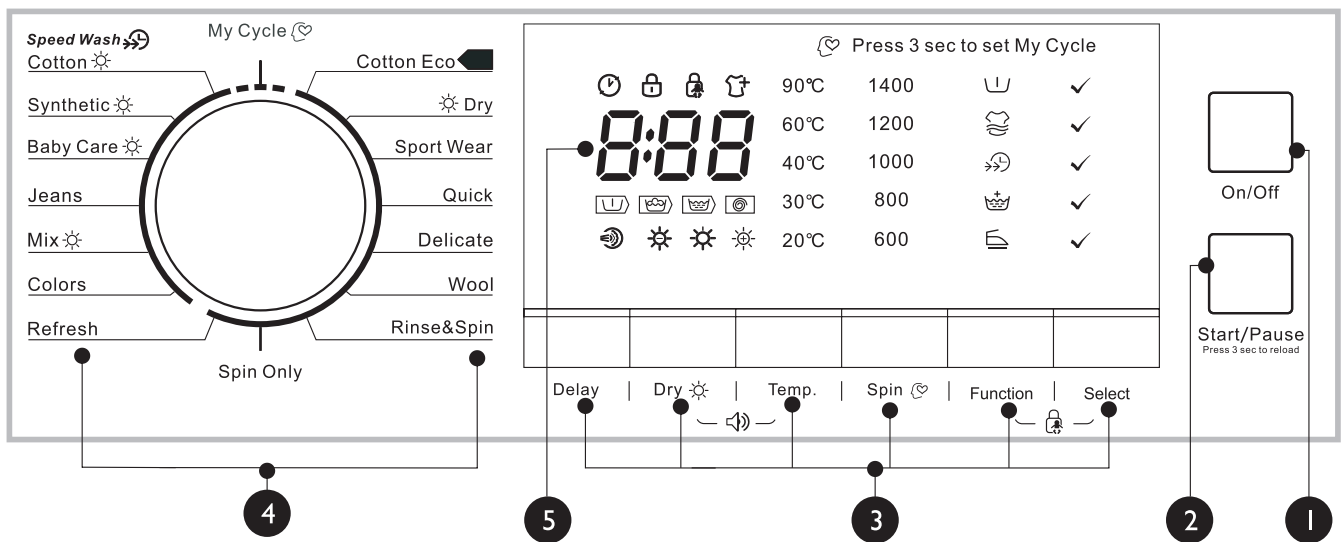





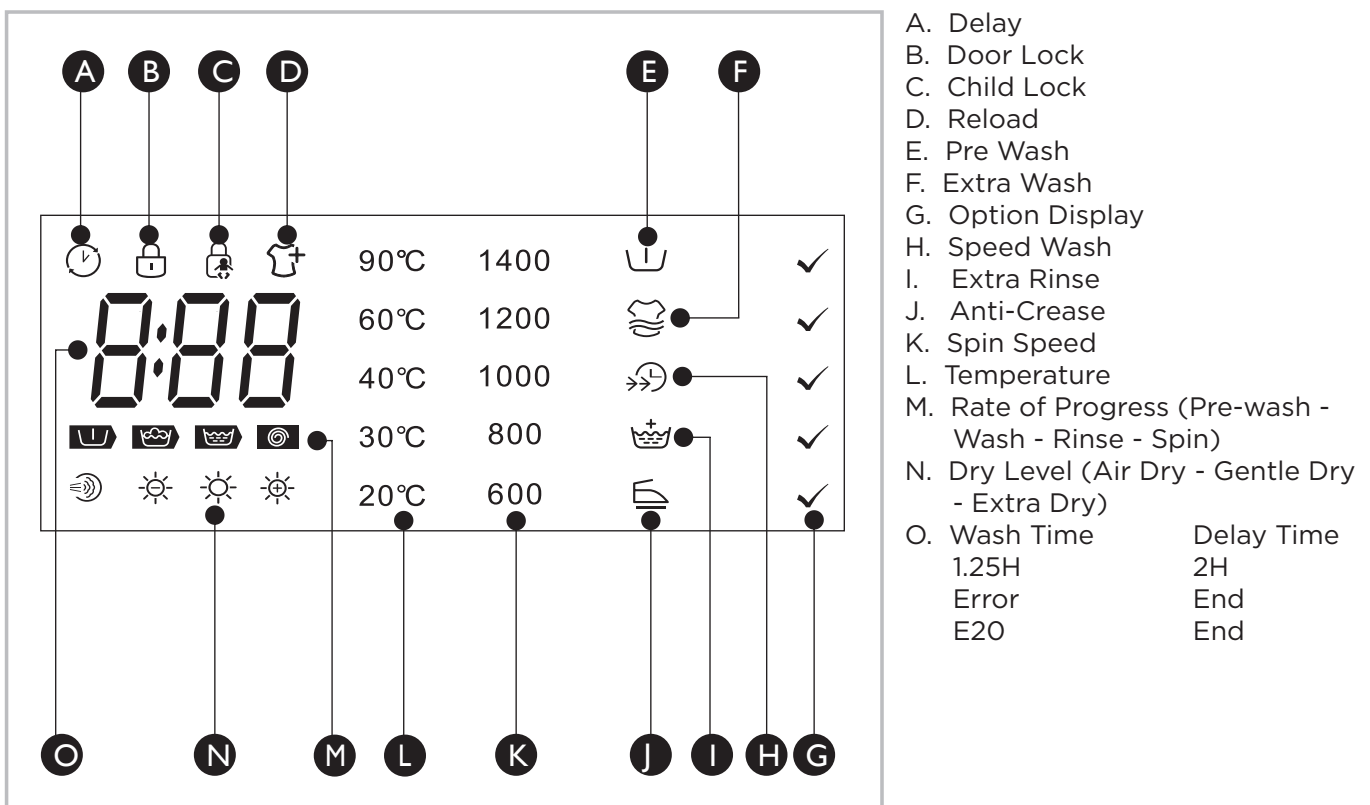



CONTROL PANEL

1. On/Off button: Product is switched on or off
2. Start/Pause button: Press the button to start or pause the washing cycle.
3. Options: This allows you to select an additional function and will light when selected.
4. Programs: Available according to the laundry type.
5. LED Screen display: The display shows the settings, estimated time remaining, options, and status messages for your washer. The display will remain on through the cycle.



OPERATIONS

Option

	<p>Pre Wash</p> <p>The Prewash function can get an extra wash before main wash, it is suitable for washing the dust rises to surface of the clothes; You need to put detergent into the Case (I) when select it.</p>
	<p>Extra Rinse</p> <p>The laundry will undergo extra rinse once after you select it.</p>
	<p>Speed Wash</p> <p>The function can decrease the washing time.</p>
	<p>Extra Wash</p> <p>Very dirty clothes can choose it, select it can increase the washing time and intensity to increase the washing effect.</p>
	<p>Anti-Crease</p> <p>It can be used to reduce the wrinkles of clothes</p>
	<p>Soak</p> <p>When water reaches the target level, sock for 20 minutes and then the motor do not rotate.</p>
	<p>Delay</p> <p>Set the Delay function:</p> <ol style="list-style-type: none"> 1. Select a programme 2. Press the Delay button to choose the time (the delaying time is 0-24 H.) 3. Press [Start/Pause] to commence the delay operation <p>On/Off Choose the Programme Setting time Start Delay</p> <div style="text-align: center;">  </div> <p>On/Off > Choose the program > Setting Time > Start</p> <p>Cancel the Delay function:</p> <p>Press the [Delay] button until the display be 0H. It should be pressed before starting the programme. If the programme already started, should press the [On/Off] button to reset the programme.</p>

CAUTION

If there is any break in the power supply while the machine is operating, a special memory stores the selected programme and when the power is restarted, press the [On/Off] button the program is continues.

OPERATIONS (Cont.)

Programme	Option					Programme	Option				
	Delay	Speed wash	Extra rinse	Extra wash	Anti-crease		Delay	Speed wash	Extra rinse	Extra wash	Anti-crease
Cotton ECO	<input type="radio"/>	<input type="radio"/>				Refresh	<input type="radio"/>				
Dry	<input type="radio"/>					Colors	<input type="radio"/>	<input type="radio"/>	<input type="radio"/>		<input type="radio"/>
Sport Wear	<input type="radio"/>		<input type="radio"/>	<input type="radio"/>	<input type="radio"/>	Mix	<input type="radio"/>	<input type="radio"/>	<input type="radio"/>	<input type="radio"/>	<input type="radio"/>
Quick	<input type="radio"/>					Jeans	<input type="radio"/>	<input type="radio"/>	<input type="radio"/>		<input type="radio"/>
Delicate	<input type="radio"/>		<input type="radio"/>		<input type="radio"/>	Baby Care	<input type="radio"/>	<input type="radio"/>	<input type="radio"/>	<input type="radio"/>	<input type="radio"/>
Wool	<input type="radio"/>		<input type="radio"/>		<input type="radio"/>	Synthetic	<input type="radio"/>	<input type="radio"/>	<input type="radio"/>	<input type="radio"/>	<input type="radio"/>
Rinse&Spin	<input type="radio"/>		<input type="radio"/>		<input type="radio"/>	Cotton	<input type="radio"/>	<input type="radio"/>	<input type="radio"/>	<input type="radio"/>	<input type="radio"/>
Spin Only	<input type="radio"/>				<input type="radio"/>						

Means optional

Other Functions

My Cycle



Start/Pause
Hold 3 sec. to Reload

Reload

This operation can be executed during the washing progress. When the drum is still rolling and there is large amount of water with high temperature in the drum.

The state is unsafe and the door cannot be opened forcefully. To press [Start/Pause] for 3 sec. to reload, and start the clothes adding in the midway function. Please follow the steps as bellow:

- 1.Wait until the drum stops rotation.
- 2.The door lock is unlocked.
- 3.Close the door when the clothes are reloaded and press the [Start/Pause] Don't use the Reload function when the water level over the edge of the inner tub or the temperature is higher.



Press [Start/Pause] 3sec.











Reload the clothes



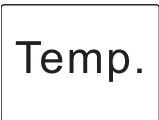

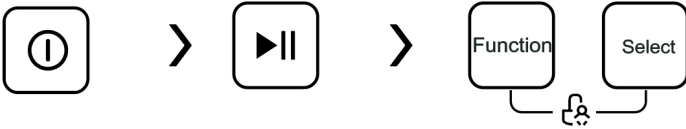

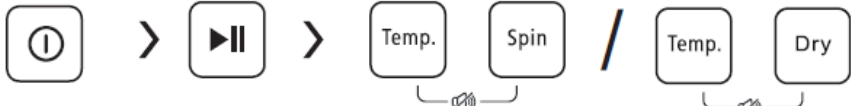
Start

CAUTION: Do not use the Reload Function when the water level over the edge of the inner tub or the temperature is higher.

OPERATIONS (Cont.)

	<p>Memory of frequently used programmes</p> <p>Press [Spin]([Dry]/[Temp.]) 3sec. to memory the running programme. The default is cotton.</p>
	<p>Spin Press the button to change the spin speed.</p> <p>1400: 0-600-800-1000-1200-1400</p> <p>CAUTION: When the lights of spin speed (600,800,1000,1200,1400) are off means the spin speed is 0.</p>
	<p>Temp.</p> <p>Press the button to regulate the temperature (Cold, 20°, 30°, 40°, 60°, 90°)</p>
	<p>Child Lock</p> <p>To avoid mis operation by children.</p> <div style="text-align: center;">  </div> <p>CAUTION</p> <p>Press the two button 3sec. also to be released the function.</p> <ul style="list-style-type: none"> • The “Child Lock” will lock all buttons except [On/Off]. • Cut off the power supply , the kid’s protection is to be released. • The child lock will remain effective when the power is resumed for some models.
	<p>Mute the buzzer</p> <div style="text-align: center;">  </div> <p>Power on Start Press the two button with “” for 3sec. the buzzer is mute.</p> <p>To act the buzzer function, press the two buttons again for 3 seconds. This setting will not change until the next reset.</p> <p>CAUTION: After muting the buzzer function, the sound will not be activated anymore.</p>

OPERATIONS (Cont.)

	<p data-bbox="352 241 1458 371">Dry Press the Dry button continuously to choose the dry level: Extra Dry/Normal Dry/Gentle Dry/Air Dry.</p> <p data-bbox="421 434 1342 501"> Extra Dry: Need to wear clothes immediately ,we can choose this function</p> <p data-bbox="421 546 1050 613"> Normal Dry: The normal dry procedure</p> <p data-bbox="421 658 1209 725"> Gentle Dry: Only to dry slightly and then is just ok .</p> <p data-bbox="421 770 1315 837"> Air Dry: Clothes is roated to remove peculiar smell without water in high temperature</p>
---	---

Drying hints

- Clothes could be dried after spinning
- To ensure quality dry the textiles,please classify them according to their kinds and the drying temperature.
- Synthetic should be set the proper drying time .
- If you want to iron the clothes after drying,please put them for a while.

Clothes not suitable for drying

- Particularly delicate items such as synthetic curtains,woolen and silk, clothes with metal inserts,nylon stockings,bulky clothes,such as anoraks,bed covers,quilts,sleeping bags and duvets must not be dried.
- Clothes padded with foam-rubber or materials similar to foam-rubber must not be machine dried.
- Fabrics containing residues of setting lotions or hair sprays, nail solvents or similar solutions must not be machine dried in order to avoid the formation of harmful vapors

GETTING STARTED

Before installing your appliance, read all safety instructions in this manual, especially the sections on electrical safety and installation.

UNPACKING

- When unpacking the appliance, be sure to keep all the packaging materials until you have made sure your new appliance is undamaged and in good working order. Plastic can be a suffocation hazard for babies and young children, make sure the materials are out of their reach.

TRANSPORTATION

- **CAUTION: VERY HEAVY!** Be sure to team lift the appliance with someone or mechanical aid is required when moving the appliance. Keep the appliance upright as possible when moving the appliance.

REMOVE TRANSPORT BOLTS

- **IMPORTANT!** Make sure before you install the appliance, you must remove the transit bolts from the back of the appliance and cover the holes with the hole covers provided. A spanner is required to remove the bolts.

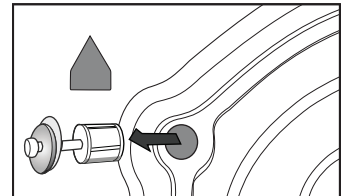

NOTE: Keep the transit bolts for future needs if you are going to move the appliance again to another location. **The bolts hold the drum in place during transportation but MUST be removed before use so the drum can move during a wash. Leaving the bolts in can result in strong shock, noise and malfunction.**

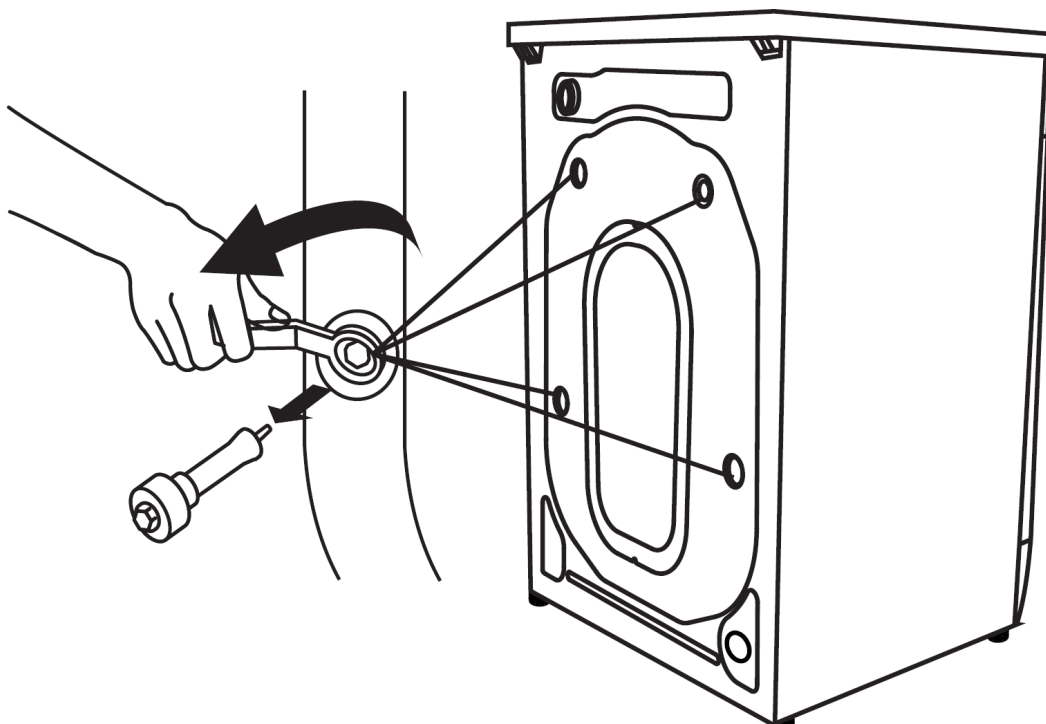

GETTING STARTED (Cont.)

LEVELLING THE APPLIANCE

IMPORTANT! Make sure to level the appliance carefully with a spirit level to ensure the most accurate levelling of the appliance. This is a must if your floor is unbalanced to level the washing machine.

- Make sure to position the appliance on a level and stable ground. If the floor is uneven you can adjust the feet by twisting foot then with a spanner you twist the lock nut to the top to lock it in place.

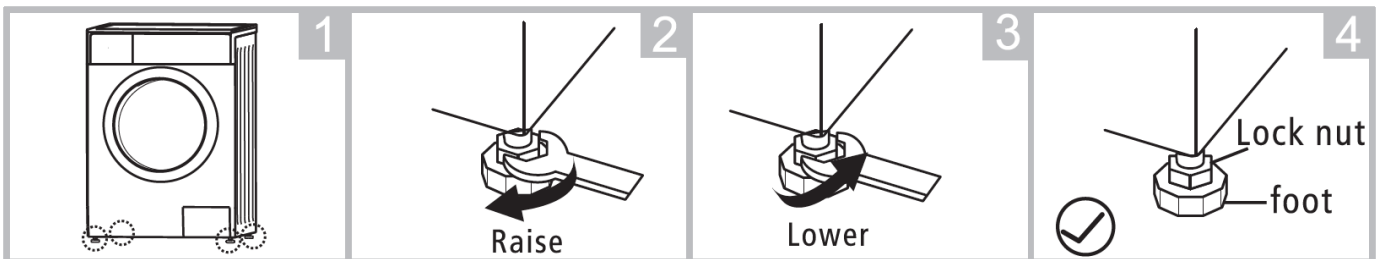

- By placing a spirit level on top of the appliance you can check correctly to aid you in adjusting the feet levelling nuts to adjust the appliance to be completely level.

INSTALLATION AREA

IMPORTANT! When installing the appliance the spacing on the side and behind the appliance must not be less the 20mm to allow proper ventillation.

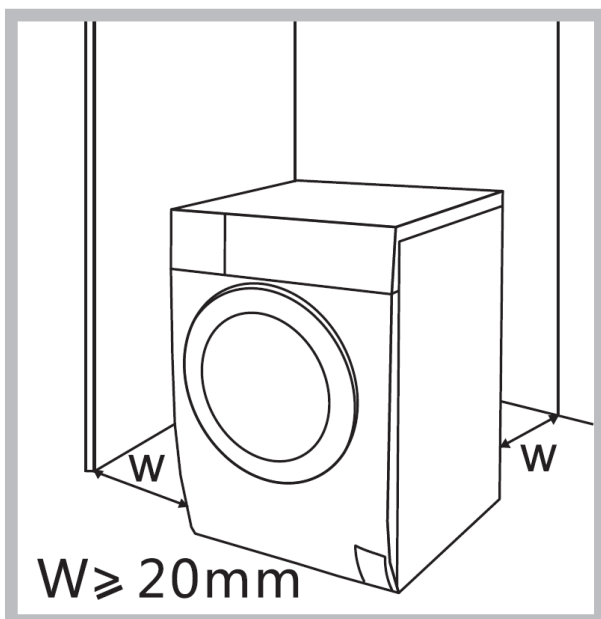

Note: Make sure to avoid direct sunlight onto the appliance.

GETTING STARTED (Cont.)

CONNECTING THE WATER INLET HOSE

IMPORTANT! To prevent leakage or water damage please follow the below instructions. Do not kink, crush, modify or sever the water inlet hose.

Minimum Inlet Water Pressure: 0.05MPa/**Maximum Inlet Water Pressure:** 1MPa

Be sure to only use new hose sets when connecting the washing machine. Do not re-use old hoses.

CONNECT THE INLET PIPE

Connect the inlet pipe as indicated in the figure. There are 2 ways to connect the inlet pipe.

INSTALL INLET PIPE

1. Connect the elbow to tap and fasten it clockwise.
2. Connect the other end of inlet pipe to the inlet valve at the backside of washing machine and fasten the pipe tightly clockwise.

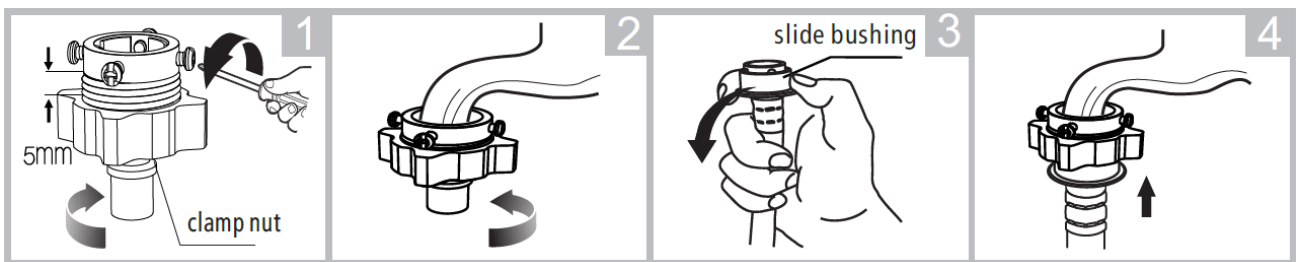

Notes: If there is any leakage with hose after connecting, then repeat the steps to connect inlet pipe. The most common type of tap shall be used to supply water. If the tap is square or too big, then the tap should be changed to a standard one.

CONNECTION BETWEEN SCREW TAP AND INLET HOSE.

1. Tap with threads and inlet hose
2. Special tap for washing machine

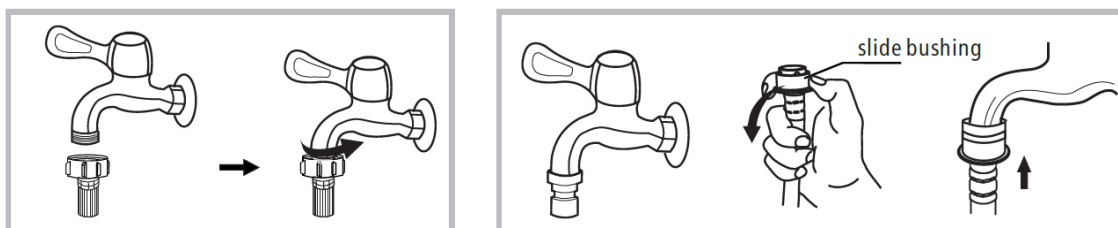

3. Connect the other end of inlet pipe to the inlet valve at the backside of product and fasten the pipe tightly clockwise.

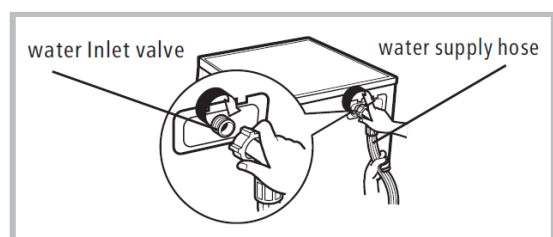

GETTING STARTED (Cont.)

CONNECTING THE DRAIN HOSE

Do not kink or protract the drain hose. Position the drain hose correctly otherwise damage will result in water leakage.

There are two ways to place the end of drain hose:

1. Put it through the water trough.

2. Connect it to the branch drain pipe.

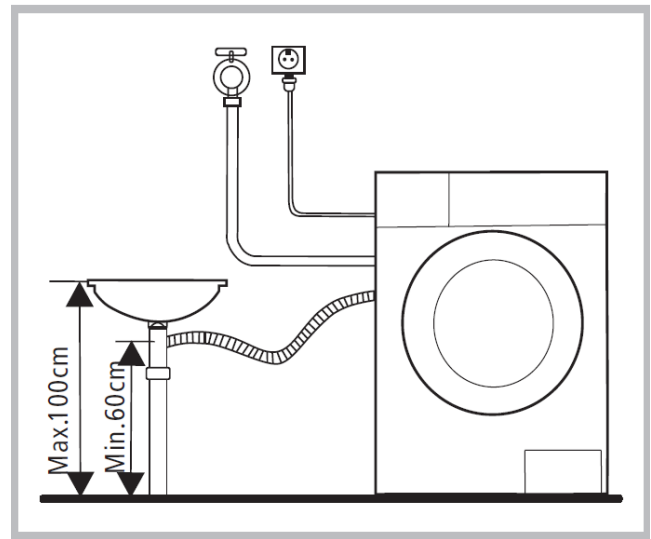
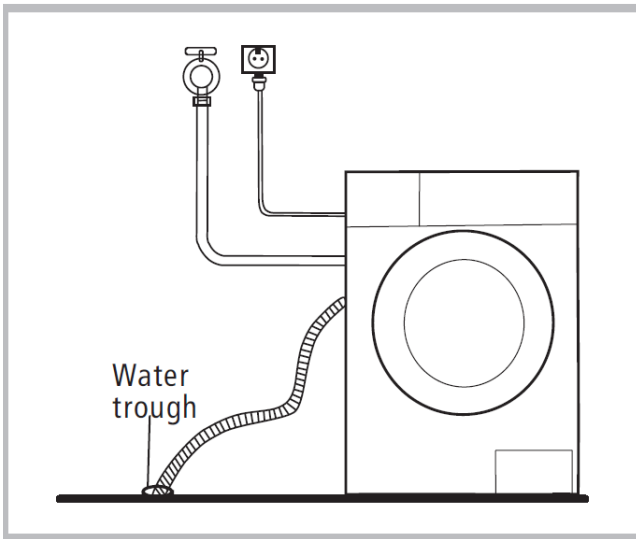

When installing the drain hose into the laundry sink, make sure it is properly fitted with rope to hold it in place. If the hose is too long, do not try to push the end where it comes from the appliance in to shorten length, this can damage it.

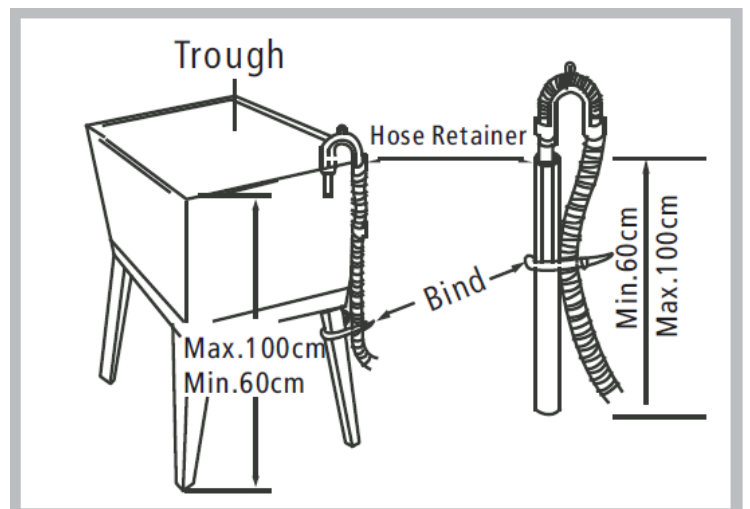
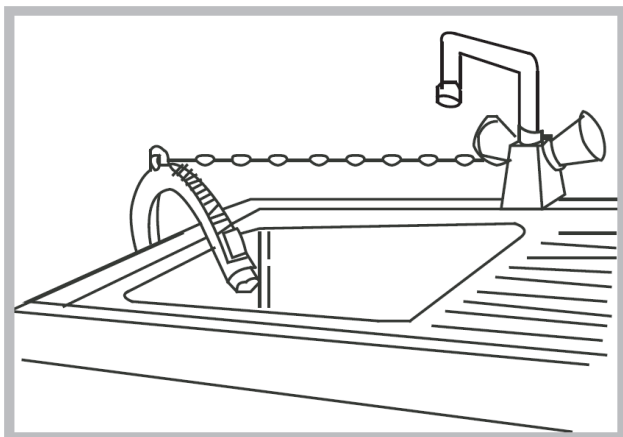

WARNING

- Make sure that the hose is not higher than 120cm above the ground, otherwise appliance will not drain the water well.
- Never lay down the drain hose otherwise water will pour out.
- Make sure the hose has no kinks so it can drain properly.

GETTING STARTED (Cont.)

Electrical connection

- As the maximum current through the unit is 10A when you are using its heating function, please make sure the power supply system (current, power voltage and wire) at your home can meet the normal loading requirements of the electrical appliances.
- Please connect the power to a socket which is correctly installed and properly earthed.
- Make sure the power voltage at your place is same to that in the machine's rating label.
- Power plug must match the socket and cabinet must be properly and effectively earthed.
- Do not use multi-purpose plug or socket as extension cord.
- Do not connect and pull out plug with wet hand.
- When connecting and pulling out the plug, hold the plug tightly and then pull it out. Do not pull power cord forcibly.

If power cord is damaged or has any sign of being broken, special power cord must be selected or purchased from its manufacturer or service center for replacement.

WARNING

- This machine must be earthed properly. If there is any short circuit, earthing can reduce the danger of electrical shock. This machine is equipped with power cord, which includes plug, earthing wire at earthing terminal.
- Washing machine shall be operated in a circuit separate from other electrical appliances. Otherwise, power protector may be tripped or fuse may be burned out.

INSTRUCTIONS

BEFORE FIRST USE

- Before any first wash make sure everything is installed correctly. Make sure to do one wash with no items inside to clean out the tube before your first loaded wash.

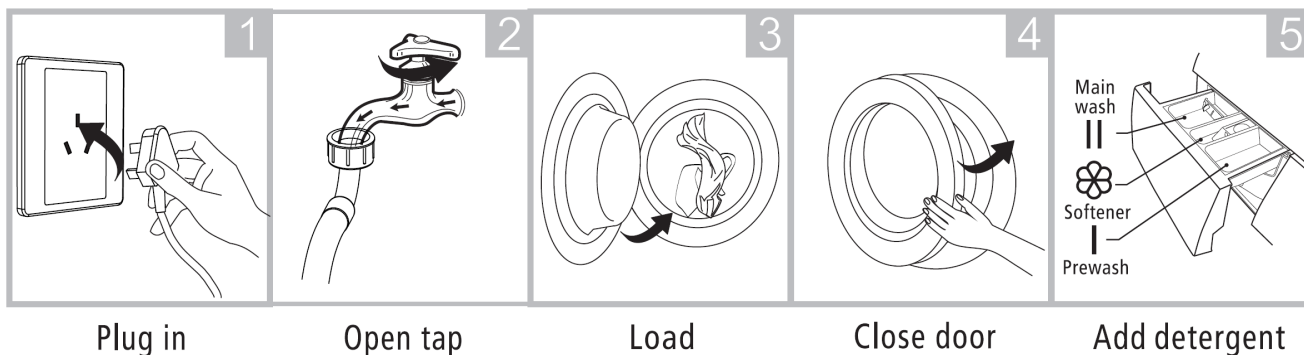

After the above steps have been completed, In a few simple steps shown below you can select the type of wash you want and get started.

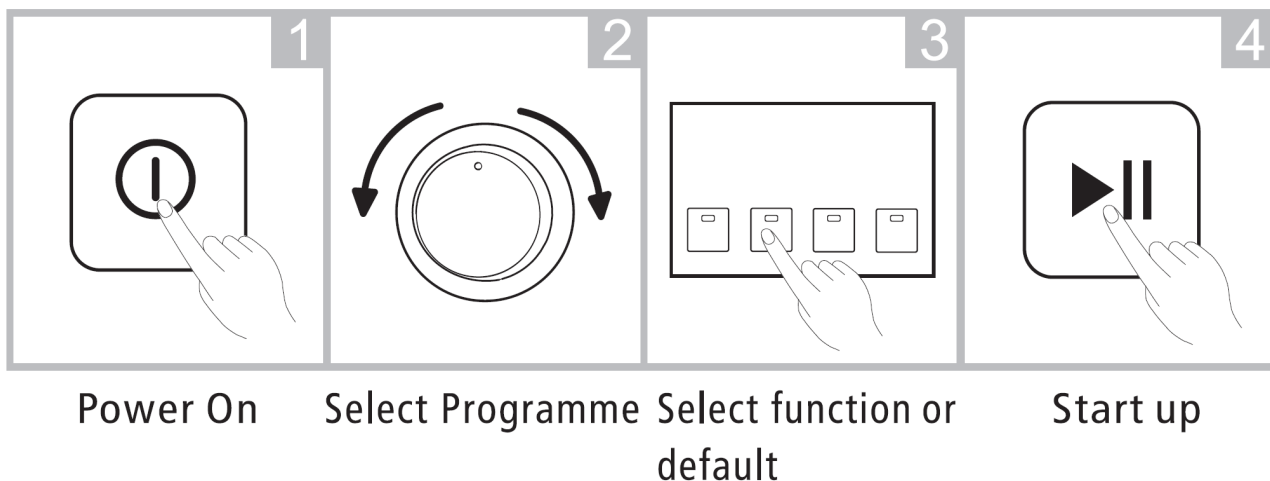

Detergent only need to be added in “case I “after selecting pre-washing for machines with this function.

Programme	I	II	☼	Programme	I	II	☼
Cotton ECO		●	○	Refresh		●	○
Dry		●	○	Colors		●	
Sport Wear	○	●	○	Mix	○	●	○
Quick		●	○	Jeans	○	●	○
Delicate	○	●	○	Baby Care	○	●	○
Wool	○	●	○	Synthetic	○	●	○
Rinse&Spin	○		○	Cotton	○	●	○
Spin Only			○				

● Means must ○ Means optional

INSTRUCTIONS (Cont.)

- As for the agglomerated or ropy detergent or additive, before they are poured the detergent box, it is suggested to use some water for dilution to prevent inlet of detergent box from being blocked and overflowing while filling water.
 - Please choose suitable type of detergent for the various washing temperature to get the best washing performance with less water and energy consumption.
 - Make sure that the appliance is in a correct working temperature (0-40 °C). If the appliance is used under 0 °C the inlet valve and draining system may be damaged.
 - Make sure that all labels are checked on items if they can be washed.
 - Use non-foaming or less-foaming detergents which are more suitable for washing machines to wash correctly.
- **Maximum mass of dry clothes for drying is 3.5kg**
Maximum mass of dry clothes for washing is 7.0kg

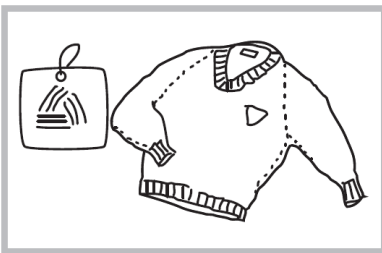

Check the label

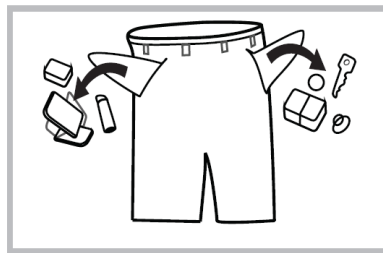

Take out the items out of the pockets

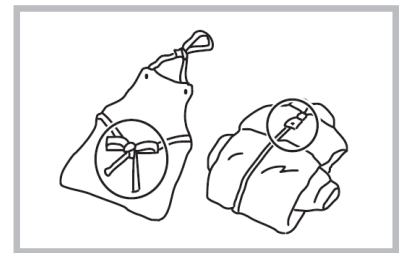

Knot the long strips, zip or button

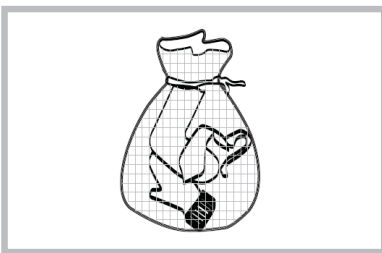

Put small clothes into the pillow slip

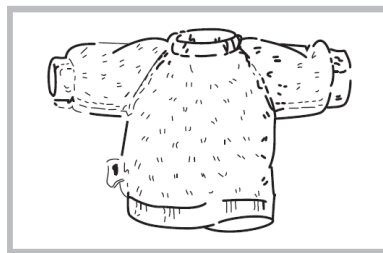

Turn easy-pilling and long-pile fabric inside out

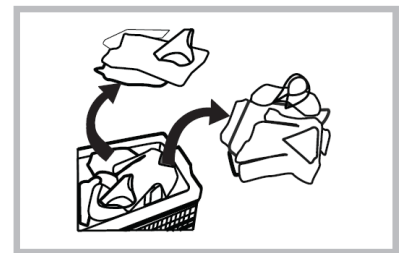

Separate clothes with different textures

WARNING

- Never use the washing machine to wash a single item at any given time, if you need to urgently wash an item, we suggest placing a few clothing items in there.
- Make sure that all labels are checked on items if they can be washed.
- Use non-foaming or less-foaming detergents which are more suitable for washing machines to wash correctly.

INSTRUCTIONS (Cont.)

WASH CARE SYMBOLS

When choosing a wash program, check for any labels on your clothes and follow the instructions. below are some commonly used symbols.

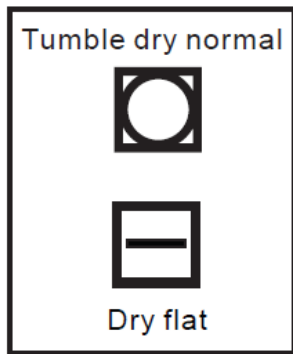
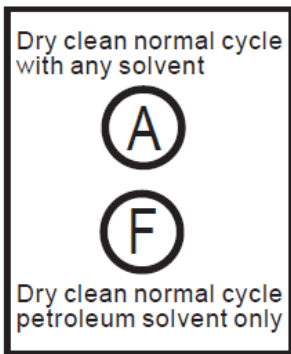
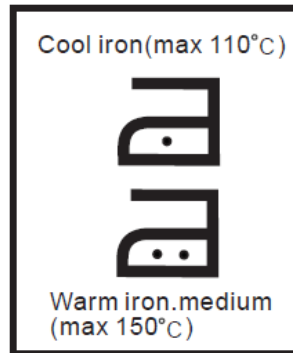
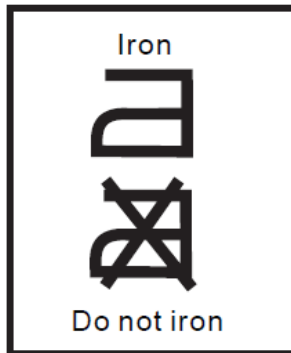
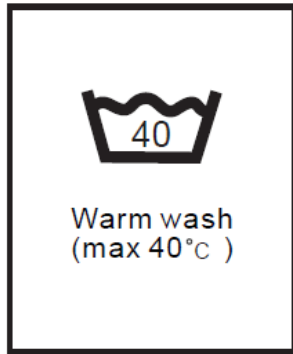
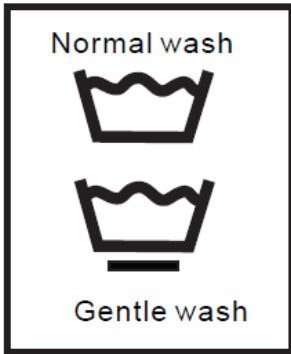

DETERGENT DISPENSER

Only use low-subsiding detergents and clothing care preparations that are for use in a front load washing machine.

INSTRUCTIONS (Cont.)

WASHING PROGRAMS TABLE

Programme	Washing/Drying Load (kg)	Temp.(°C)	Default Time(H)	Default Speed(rpm)
	7.0	Default	7.0	7.0
			1400	1400
Cotton ECO	7.0	60	4:56	1400
☀ Dry	—/3.5	—	3:15	1400
Sportwear	3.5	40	0:45	1200
Quick	2.0	Cold	0:15	800
Delicate	2.0	30	0:50	600
Wool	2.0	40	1:07	600
Rinse&Spin	7.0	—	0:20	1000
Spin Only	7.0	—	0:12	1000
Refresh	7.0	—	0:50	-
Colors	7.0	Cold	1:10	1000
☀ Mix	7.0/3.5	40	1:13	800
Jeans	7.0	60	1:45	800
☀ Baby Care	7.0/3.5	30	1:20	800
☀ Synthetic	3.5/3.5	40	1:40	800
☀ Cotton	7.0/3.5	40	2:40	800

Speed: the highest speed; Other as the default.

- Half load for 7.0Kg machine:3.5Kg.
- “Cotton ECO 60°C ” is the standard washing programs to which the information in the label and the fiche relates, Energy test program: Cotton ECO 60°C and they are suitable to clean normally soiled cotton laundry and that they are the most efficient programmes in terms of combined energy and water consumptions for washing that type of cotton laundry, that the actual water temperature may differ from the declared cycle temperature.

The parameters in this table are only for user’s reference. The actual parameters maybe different with the parameters in above mentioned table.

Note: The programme with ☀ can be choose dry function

OPERATIONS

PROGRAMS

Select the desired programs according to the clothes that are being washed.

PROGRAMS	
Cotton	Hard-wearing textiles, heat-resistant textiles made of cotton or linen.
Synthetic	Wash synthetic articles such as shirts, coats, etc... While washing knitting textiles, detergent quantity should be reduced as it can easily form bubbles.
Quick 15'	It is suitable for washing few clothes which are not very dirty quickly.
Baby Care	Baby care program with extra rinse.
Jeans	Specially for jeans.
Mixed	Use on tough clothes that need extended time.
Colors	Suitable to wash bright colours.
Cotton Eco	Washes for longer time.
Sports	To wash active wear
Delicate	For delicate washable textiles (made of silk, satin, synthetic fibres or blended fabrics).
Wool	Select the desired temperature to wash wool fabric.
Delay 24h	The function can be set with any program which will delay when the washing commences.
Drum Clean	This Program is to be only used to clean out the drum. NO ITEMS are to be inside when this is to be used, its only to be used for cleaning the drum at a high temperature for pure sterilization of the drum.
Spin Only	Extra spin with selectable spin speeds.
Rinse & Spin	Extra rinse with spin.
Drain Only	Drain out the water.
Dry Only (Dry)	Select it to dry clothes, the temperature is different . The drying time according to the load .
1Hour W/D	Select it to dry clothes,the time less than 1 hour, The default load is 1kg.

OPERATIONS (Cont.)

Refresh	During this cycle, there is only hot air rather than water ejecting from inside the drum to wash the clothing.
Rapid 45'	It is suitable for washing not very dirty clothes, save more energy and washing.

MY CYCLE

Save your most frequently used washing cycle as a favourite.

To do this:

1. Press and hold Speed/Temp for 3 seconds while your desired cycle is in progress.
2. When starting a load of washing, Turn the dial to “My Wash” then “Start/Pause” to begin.

CHILD SAFETY LOCK: Press and hold “Delay” & “Speed” until light activates child safety lock. Press and hold both buttons again to de-activate.

CLEANING AND MAINTENANCE

WARNING:

- Before starting maintenance, ensure that the appliance is unplugged and close the tap.

CLEANING THE CABINET

Proper maintenance on the washing machine can extend its working life.

The surface can be cleaned with diluted non-abrasive neutral detergents when necessary.

If there is any water overflow, use a wet cloth to wipe it off immediately. Make sure no sharp items are used to clean the appliance.

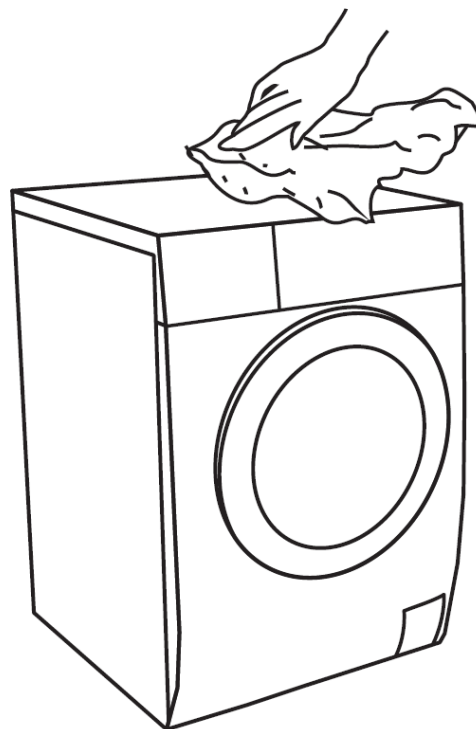

CLEANING THE DOOR SEAL AND GLASS

Wipe the glass and seal after each wash to remove lint and stains. If lint builds up it can eventually cause leaks. Remove any coins, buttons or other objects from the seal (if any) after each wash.

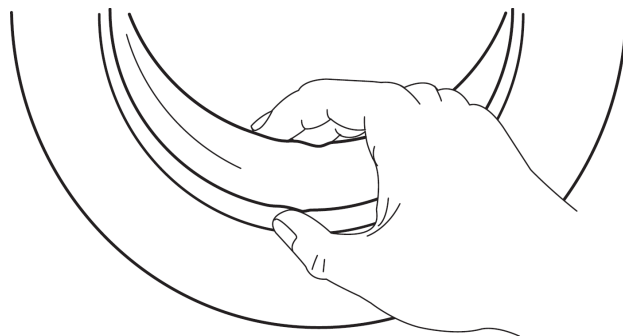

CLEANING AND MAINTENANCE (Cont.)

CLEANING THE INLET FILTER

Washing the filter in the tap

1. Close the tap
2. Remove the water supply hose from the tap
3. Clean the filter
4. Reconnect the water supply hose

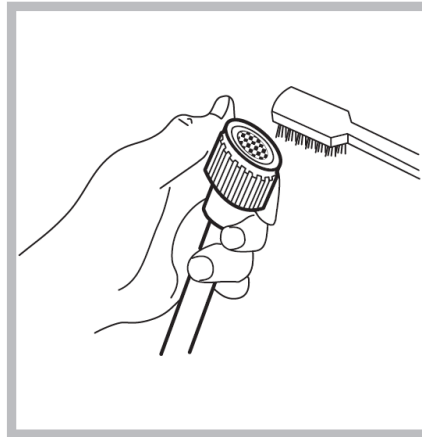
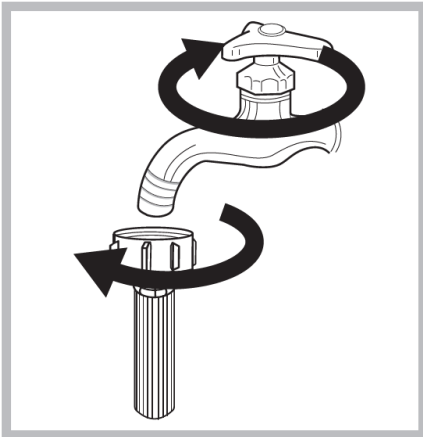

Washing the filter in the washing machine

1. Screw off the inlet pipe from the back of appliance
2. Pull out the filter with long nose pliers and reinstall after being washed
3. Use the brush to clean the filter
4. Reconnect the inlet pipe and turn on the tap

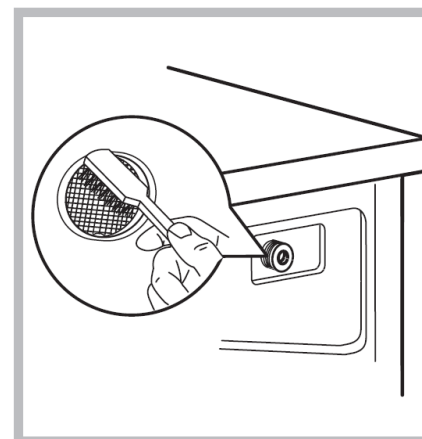
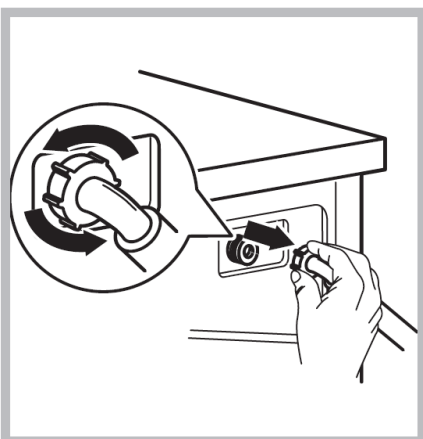

CLEANING AND MAINTENANCE (Cont.)

CLEANING THE DETERGENT DISPENSER

1. Press down the arrow location on softener cover inside the dispenser drawer.
2. Lift the clip up and take out softener cover and wash all grooves with water.
3. Restore the softener cover and push the drawer into position.

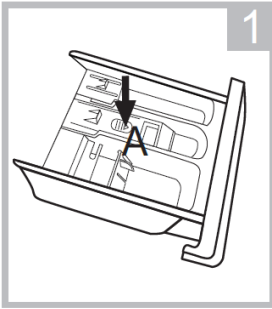

Pull out the dispenser drawer with press the A

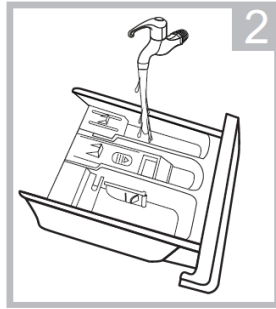

Clean the dispenser drawer under water

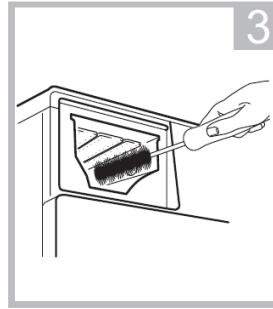

Clean inside the recess with an old toothbrush

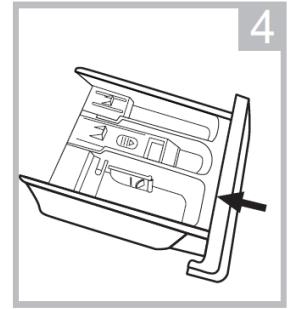

Insert the dispenser drawer

Note: Do not use alcohol, solvents or chemical products to clean the machine.

CLEANING THE DRAIN PUMP FILTER

- 1 Be careful of the hot water.
- 2 Allow the detergent solution to cool down.
- 3 Drain pump filter can filter the yarns and small foreign matters from the washing.
- 4 Clean the filter periodically to ensure the washing machine operates normally.

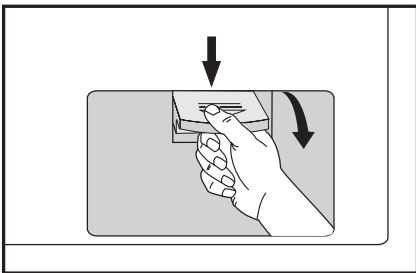

1. After the power is disconnected, open the filter cover.

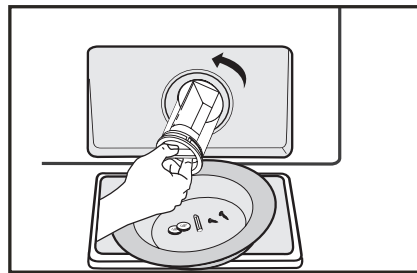

2. Turn the filter down as shown with the figure and take out sundries matters.

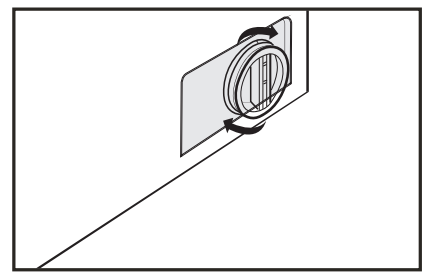

3. Reinstall each part back after sundries matters are removed.

CAUTION

- Make sure that the valve cap and drain hose are reinstalled properly. Cap plates should be inserted aligning to hole plates otherwise water may leak.
- When the appliance is in use and depending on the program selected there can be hot water in the pump. Never remove the pump cover during a wash cycle, always wait until the appliance has finished the cycle and is empty. When replacing the cover ensure it is tightly secured.

FAQs

Problem	Possible Cause	Solution
Washing machine is not starting	Door is not closed properly	Restart after the door is closed, check if the clothes are stuck
Door can't be opened	Washer's safety protection is active	Disconnect the power and restart the appliance
Water Leakage	The connection between inlet pipe or outlet hose is not tight	check and fasten water pipes. Clean up outlet hose.
Detergent residues are in the dispenser	detergent might be dampened	Clean and wipe the detergent dispenser
Indicator or display isn't working	Disconnect the power, PC board or harness may have a connection problem.	Check if the power is on and the power plug is connected correctly.
Abnormal Noise		Check if the Transport bolts at the back of the appliance have been removed. Check it's installed on a level and solid floor.

Display LED	Description	Possible Cause	Solution
E30	Door lock problem	Door is not closed properly.	Restart after the door is closed.
E10	Water injecting problem while washing	<ul style="list-style-type: none"> • Tap is not opened or water flows too slowly. • Inlet valve filter is blocked. • Inlet pipe is twisted. • If water is not supplied 	<ul style="list-style-type: none"> • Open the tap or wait until the water supply becomes normal. • Check inlet valve filter • Straighten the water pipe • Check the other taps in the room.

CLEANING AND MAINTENANCE (Cont.)

E21	Drain problem while washing	<ul style="list-style-type: none"> • Outlet hose is blocked or twisted • Drain pump is blocked 	<ul style="list-style-type: none"> • Wash and straighten outlet hose. • Wash drain pump filter
E12	Water overflow		<ul style="list-style-type: none"> • Restart the washer
EXX	Others		<ul style="list-style-type: none"> • Please try again first or call the customer helpline (1300 296 699) if problems persists.

SPECIFICATIONS

Power Supply	220-240V-50Hz
Standard Water Pressure	0.05MPa-1MPa
Washing Capacity	7KG
Drying Capacity	3.5KG
Rated Power	2100W
Drying Power	1300W
Max. Current	10A
Max Spin Speed	1400 RPM
Dimensions	595 (w) x 565 (d) x 850 (h) mm
Weight:	Gross: 78kg

SEIKI

CUSTOMER HELPLINE:

1300 296 699

DISTRIBUTED BY:

Ayonz Pty Ltd

VERSION:

2.0